







## 90° Fittings for Flexible Conduits for Non-Armoured Cables

# E-LUPUS

Technical Details		
<b>Material</b>	<b>Body, Cap</b> Brass, Brass Nickel Plated, Stainless Steel 316L <b>Seal</b> CR (Chloroprene), Silicone <b>Ferrule</b> Steel Zinc Plated, Brass Nickel Plated <b>Plastic Ring</b> Polyamide <b>O-ring</b> CR (Chloroprene), Silicone	
<b>Ingress Protection Rating</b>	IP 68 - 5 Bar, 30 min IP 66	
<b>Operating Temperature</b>	<b>Seal Material</b> <b>CR (Chloroprene)</b> -40°C to +80°C <b>Silicone</b> -60°C to +80°C <b>Ex d/tb</b> -40°C to +80°C <b>Ex e/tb</b> -40°C to +80°C	
<b>Equipment For</b>	Gas & Dust potentially explosive atmospheres	
<b>Suitable for use in</b>	Group II      Gas Group IIC      ZONE1/ZONE2 Group III      Dust Group IIIC      ZONE21/ZONE 22	
<b>Equipment Marking</b>	Ex II 2GD Ex db IIC Gb Ex eb IIC Gb Ex tb IIIC Db	
<b>Marking Example *</b>	BMD EBLN.. CE 0722  II 2GD Ex db IIC Gb Ex eb IIC Gb Ex tb IIIC Db Ta-40°C +80°C IP66/68 CESI 13 ATEX 018X IECEx CES 13.0006X	
<b>Thread Type</b>	<ul style="list-style-type: none"> <li>• Metric (M) ISO Pitch 1,5</li> <li>• NPT (N) ANSI ASME B1.20.1</li> <li>• Other thread types also available upon request.</li> </ul>	
<b>Cable Type</b>	Non Armoured	
<b>Accessories</b>	<ul style="list-style-type: none"> <li>• Lock nuts</li> <li>• Gaskets (Washers)</li> <li>• Serrated Washers</li> <li>• Earth tags</li> </ul>	
<b>Remarks</b>	<ul style="list-style-type: none"> <li>• Accessories must be ordered separately.</li> <li>• O-ring available in Metric outer threads.</li> </ul>	
Approvals	Certificate Number	Standards
	IMQ 13 ATEX 018X	EN 60079-0:2012+A11:2013 EN 60079-7:2015 EN 60079-31:2014 EN 60079-1:2014
	IECEx IMQ 13.0006X	IEC 60079-0:2011 Edition:6 IEC 60079-7:2015 Edition:5 IEC 60079-31:2013 Edition:2 IEC 60079-1:2014 Edition:7
	№ TC RU C-TR.AA87.B.00941	ГОСТ 31610.0-2014 ГОСТ IEC 60079-1:2013 ГОСТ IEC 60079-31:2013
	DNV 12.0052 X	ABNT NBR IEC 60079-0:2013 ABNT NBR IEC 60079-1:2009 ABNT NBR IEC 60079-7:2008 ABNT NBR IEC 60079-31:2011
	E-14044	IEC/EN60079-0 IEC/EN60079-7 IEC/EN60079-31 IEC/EN60079-1 IEC/EN 62444

-For more information see our webpage.  
\* The standard marking consists ATEX & IECEx only. Marking acc. to other standards on request.

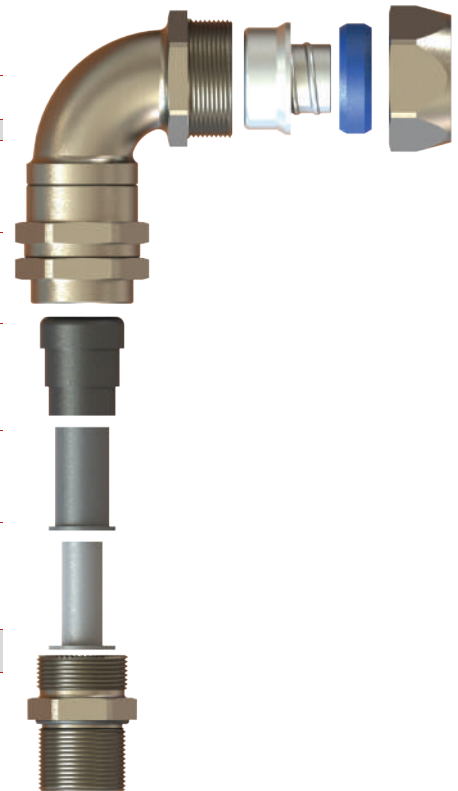

Order Coding								
Part Number	Material	Seal	-	Gasket (Washer)	Serrated Washer	Lock Nut	Earth Tag	for Ex e
See table	Mandatory	Mandatory	-	Option	Option	Option	Option	Option
	B Brass BN Brass Nickel plated X Stainless steel 316L	C Chloroprene S Silicone	-	WC Chloroprene WS Silicone WF Fiber	WSR Serrated washer	L Lock nut	E Earth tag	TL9
Example								
EBLN3M	BN	S	-	WC	WSR	L	E	TL9

# E-LUPUS

## 90° Fittings for Flexible Conduits for Non-Armoured Cables

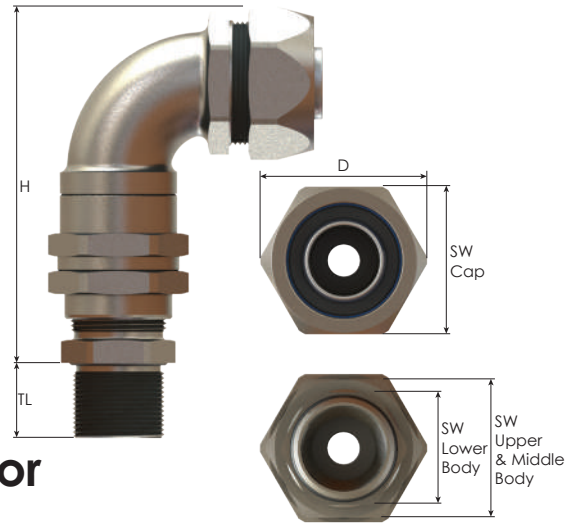

### Thread Type METRIC acc. to ISO 965-3

Outer Thread Size (Male)	For Sealtite Nominal Size	Clamping Range		Outer Thread Length		Cap	Spanner Width			Outer Ø	max. Height	Part Number
		Ø min-max mm	Seal Type	Ex-e min.	Ex-d/e min.		Upper Body	Middle Body	Lower Body			
				TL mm		SW Cap mm	SW Upper Body mm	SW Middle Body mm	SW Lower Body mm	D mm	H mm	
M12x1,5	1/2"	4,0 - 8,0	Triple	9,0	16,0	29	27	27	22	32,7	83,5	*EBLN02M
M16x1,5	1/2"	4,0 - 12,0	Triple	9,0	16,0	29	27	27	22	32,7	83,5	EBLN01M
M20x1,5	3/8"	4,0 - 10,0	Triple	9,0	16,0	26	22	27	22	29,0	75,0	EBLN1SM
	1/2"	4,0 - 12,0	Triple	9,0	16,0	29	27	27	22	32,7	80,0	EBLN1M
M25x1,5	3/4"	10,0 - 18,0	Triple	9,0	16,0	35	33	33	28	39,0	90,0	EBLN2M
M32x1,5	1"	14,0 - 24,0	Triple	9,0	16,0	45	42	42	35	50,0	104,0	EBLN3M
M40x1,5	1 1/4"	22,0 - 32,0	Triple	9,0	18,0	54	51	51	45	60,0	122,0	EBLN4M
M50x1,5	1 1/2"	26,0 - 35,0	Triple	9,0	18,0	63	60	60	55	69,3	137,0	EBLN5M

### Thread Type NPT acc. to ANSI ASME B1.20.1

Outer Thread Size (Male)	For Sealtite Nominal Size	Clamping Range		Outer Thread Length	Cap	Spanner Width			Outer Ø	max. Height	Part Number
		Ø min-max mm	Seal Type			Upper Body	Middle Body	Lower Body			
				TL mm	SW Cap mm	SW Upper Body mm	SW Middle Body mm	SW Lower Body mm	D mm	H mm	
NPT 1/4"	1/2"	4,0 - 8,0	Triple	16,0	29	27	27	22	32,7	83,5	*EBLN02N
NPT 3/8"	1/2"	4,0 - 12,0	Triple	16,0	29	27	27	22	32,7	83,5	EBLN01N
NPT 1/2"	3/8"	4,0 - 10,0	Triple	16,0	26	22	27	22	29,0	75,0	EBLN1SN
	1/2"	4,0 - 12,0	Triple	16,0	29	27	27	22	32,7	79,5	EBLN1N
NPT 3/4"	3/4"	10,0 - 18,0	Triple	16,0	35	33	33	28	39,0	89,5	EBLN2N
NPT 1"	1"	14,0 - 24,0	Triple	20,0	45	42	42	35	50,0	104,0	EBLN3N
NPT 1 1/4"	1 1/4"	22,0 - 32,0	Triple	20,0	54	51	51	45	60,0	122,0	EBLN4N
NPT 1 1/2"	1 1/2"	26,0 - 35,0	Triple	20,0	63	60	60	55	69,3	137,0	EBLN5N